



More Precision.

ASCOSpeed 5500

non-contact speed measurement



Powerful due to optimum functionality

The ASCOSpeed 5500 is a powerful speed sensor which has been focused on applications in the metal industries. It operates according to the signal phasing group method and is therefore a further development within the proven spatial frequency filter technology. Thereby the moved material surface and measured by means of the precise grid structure of the detector and converted into an electrical frequency which is proportional to the speed of the object.

A strong base due to many years of experience

The spatial frequency filter method has been known for more than 40 years. Commonly model described as the "picket fence effect", the flashing frequency is proportional to the speed of a moving light source behind the "pickets". The "picket spacing" as a sensitive silicon grid and associated with more than 15 years of practical experience mark the outstanding features of this new powerful generation of speed and length measure equipment.



Photo (c) ThyssenKrupp Steel Fotografie

Ease of use due to non-hazardous LED light source

A high-performance LED is used as the light source. The back-scattered light from the passing object surface strikes the detector via a lens which generates the measurement signal. LEDs are on a par with semiconductor lasers as regards service life. However, with the LED Class 1, they represent a clearly reduced potential hazard as compared with the known Laser Doppler Velocimeters (LDV) principle.

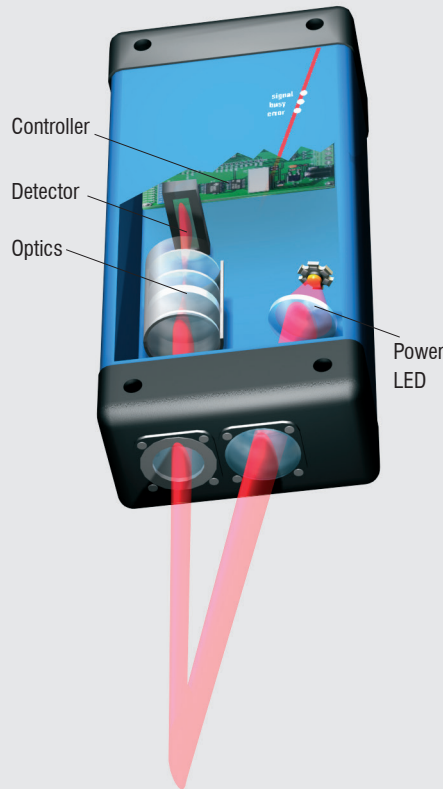

Maximum dynamics due to fast, adapted hardware

State-of-the-art signal processing structures ensure that each change in the material speed is measured precisely. This is provided by extremely fast hardware which is able to register, check and compress the current speed values in the microseconds range up to maximum material speeds of 3000 m/min. It is only in this way that maximum precision can be realised for acceleration processes. The sensor also provides a reliable speed signal for the minimal averaging and output time of 0.5 milliseconds.

Always one step ahead

Conventional mechanical systems can be replaced without problems by the ASCOSpeed 5500. The device has free scaleable quadrature pulse output channels and can therefore be used as an alternative to rotary shaft encoders. The synchronous operation provides significant benefits for the measurement of differential speeds such as for mass flow control or skin pass level control. Using trigger pulse from the controller, several hardware-controlled measuring process devices can operate exactly synchronously and in this way provide more precise results in acceleration phases. The master / Slave operation of two autonomous ASCOSpeed gauges now makes possible the output of differential speed without additional PLC using internal calculation functions in the Master gauge. The interconnection of several devices in inspection lines simplifies the transmission of the speed information.

Flexibility and compactness due to integrated design

The compact design combines sensor and controller in one robust case and thus guarantees use in many different systems without problems. The device operates autonomously, has low power consumption and thus only needs a 24 VDC power supply. Internal temperature monitoring makes possible the integration in the controller of climatised applications and thus increases the operational reliability. Standardised interfaces open up many possibilities for the user in the automation of process lines.



Photo (c) ThyssenKrupp Steel Fotografie

Model	ASCOSpeed 5500
Measuring range	1-3000 m/min
Reference distance	300 ± 15mm 300 ± 30mm ¹⁾
Linearity	± 0.05% ^{2) 4)}
Repeatability	± 0.03% ^{3) 4)}
Resolution	0.1mm / 0.001 m/min
Update-time (least averaging-time)	0.5ms
Light source	Power-LED (safety class 1)
Signal conditioning	compact housing with integral electronics
Protection class	IP65 (suitable for cold-rolling-mill application by using the stainless steel protective housing with air-purging and viton-seams)
Vibration (DIN EN 60068-2-6)	2g / 20 ... 500Hz, sinoidal
Shock (DIN EN 60068-2-29)	15g / 6ms, half sinoidal
Operating temperature	0°C to 50°C (without external cooling)
Storage temperature	-20°C to 70°C
Output	Standard: 2 encoder outputs (A, B, /A, /B), 3 alarm, 3 status Optional: 2 further encoder outputs (A, B, /A, /B), synchronisation output; analogue output (4 - 20mA) All outputs opto-insulated
Digital Data-Interfaces	Standard: 1x RS232 (Service or parameterization interface) Optional: 1x RS232, 1x RS232 o. RS422 (switchable) Optional: EtherCAT-ready (compatible with Beckhoff EL6021/KL6041) All serial interfaces are optically isolated
Input	Standard: Direction- and trigger inputs Optional: 3 further control- or pulse inputs All inputs optically coupled with current delimiter resistors
LED	1. Signal (LED green/red) 2. Busy (yellow) 3. Error (red)
Power supply	24VDC ± 15% / P < 50W
Weight	5.6kg

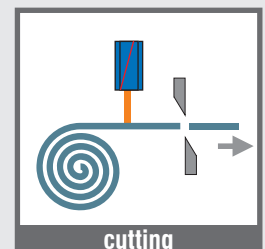
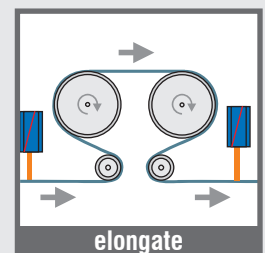
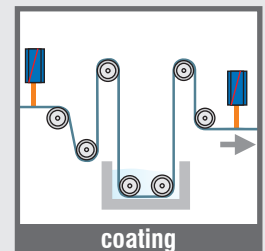
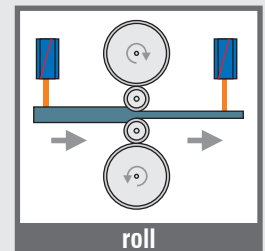

¹⁾ Extended measuring distance with restricted measurement uncertainty of 0.1%
²⁾ Deviation of the sensor characteristic for speed respectively length from a straight line, bigger than 15 m/s extended area with 0,1 %
³⁾ Statistical probability 2 sigma, distribution measured at 5 m/s
⁴⁾ Testing condition: metal surface, 10 m reference length, basic measuring distance 300 mm, temperature = 20 °C (constant), tilting less than 0,1 degree

Product key

ASP5500-300-X-X-X-X-X

- O - Standard (without protection housing)
- E - Heavy Duty Version, (Stainless steel protection housing)
- O - without direction detection
- D - with direction detection
- O - Standard
- S - Synchron Version
- M - Master-Slave Version (with Interface)
- O - without Interface
- I - with interface
- A - Standard Distance Range (300±15mm)
- R - Long Distance Range (300±30mm)

Most requested system configuration

- ASP5500-300-A-0-0-0-0 Standard Version
- ASP5500-300-A-I-0-0-0 Version with interface
- ASP5500-300-A-I-S-D-0 Synchron Version with interface and direction detection
- ASP5500-300-A-I-S-D-E Synchron Version, Heavy Duty (Stainless steel protection housing)
- ASP5500-300-A-I-M-D-0 Master-Slave-Version with interface and automatic direction detection

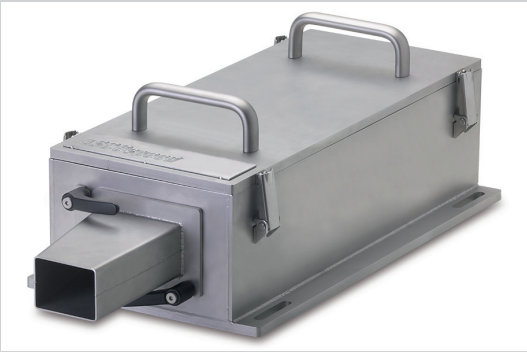

Stainless steel protection housing SGH5500

Scope of supply

- ASCOspeed 5500

Accessories

- Supply cable PC5500-5, length 5m
- Service cable C5500-5, length 5m
- Connector for interface output IF1 (or IF2, IF3)
- Interface cable SC5500-5/IF1 (IF2, IF3), length 5m, with connector and open cable tail
Other cable length on request
- Stainless steel protection housing SGH5500 (picture on the left)
Connection for air purging, contains Viton-seals for a usage in rolling mill applications
Reference distance: without tube 265mm, with tube 115mm, variable through slots
Weight (with sensor): appr. 33kg

Dimensions (in mm, not to scale)

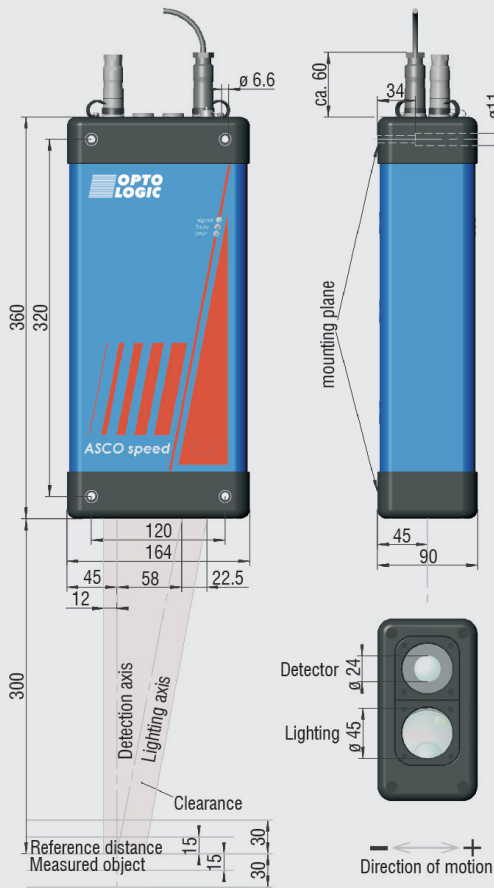

Sensor ASCOspeed 5500

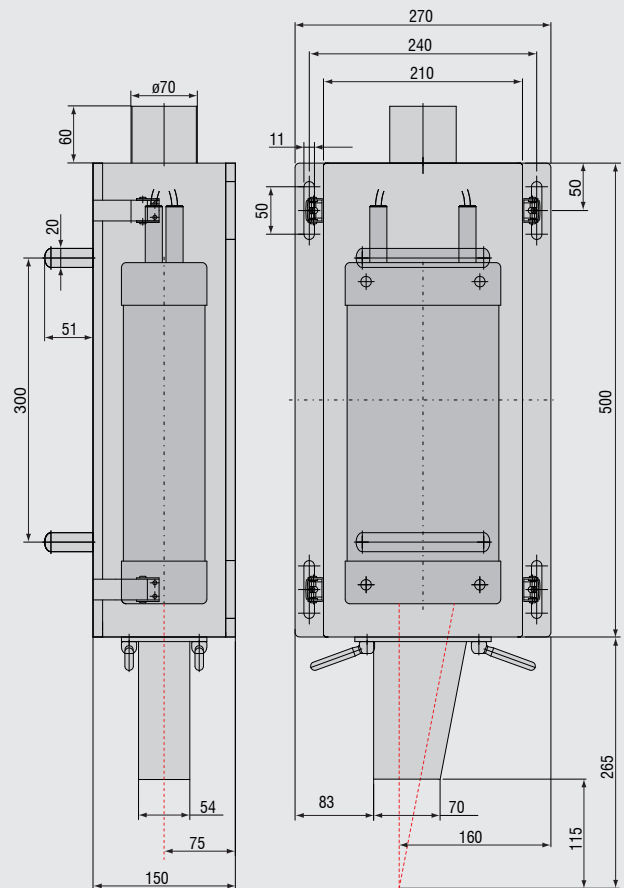

Stainless steel protection housing SGH5500

